

Fundamentplan Dreh Sperre Standard 115 - 1 m

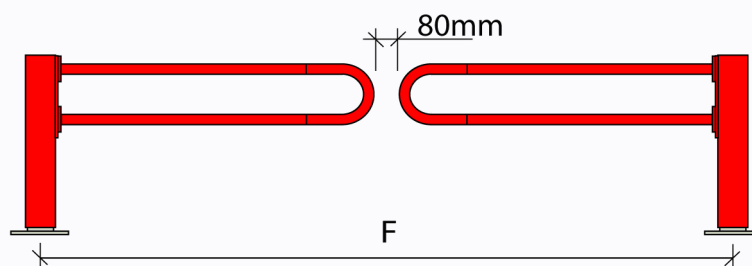
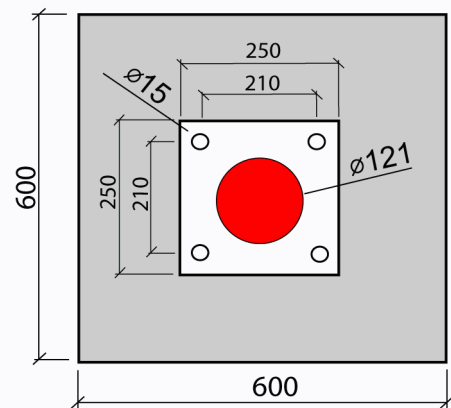
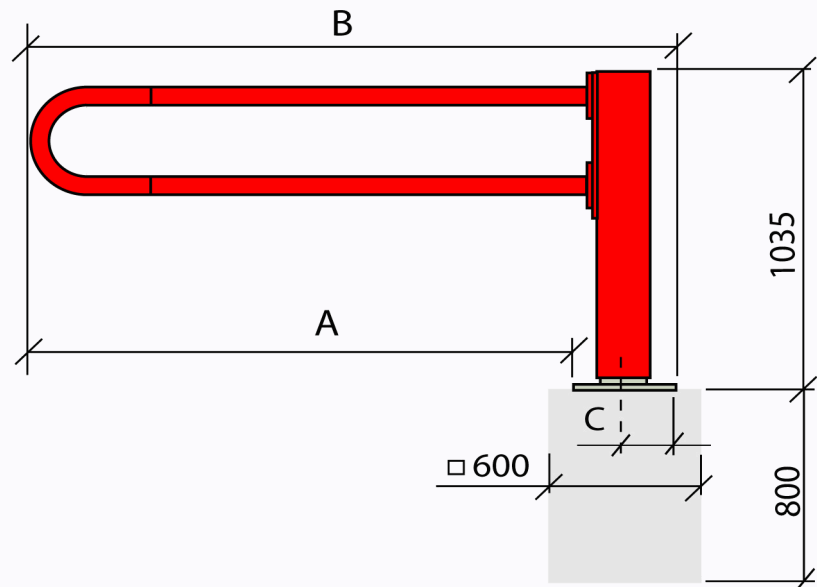
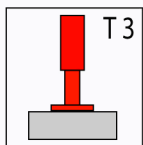

Durchfahrbreite A = 954 mm
Gesamtbreite B = 1204 mm
Überstand C = 125 mm

Fundamentabstand
gegenläufiger Fundamentabstand

D = 0 mm
F = 2240 mm