

Fundamentplan Dreh Sperre Standard 115 - 2,5 m

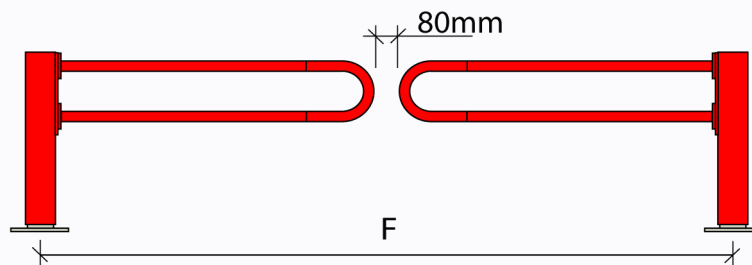
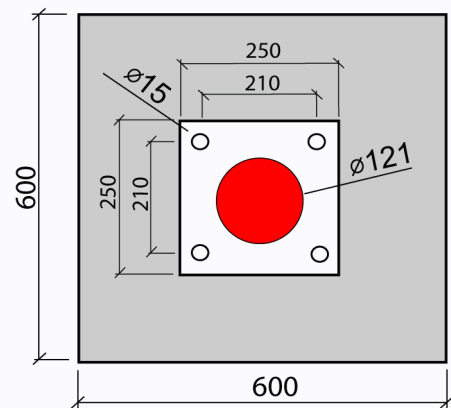
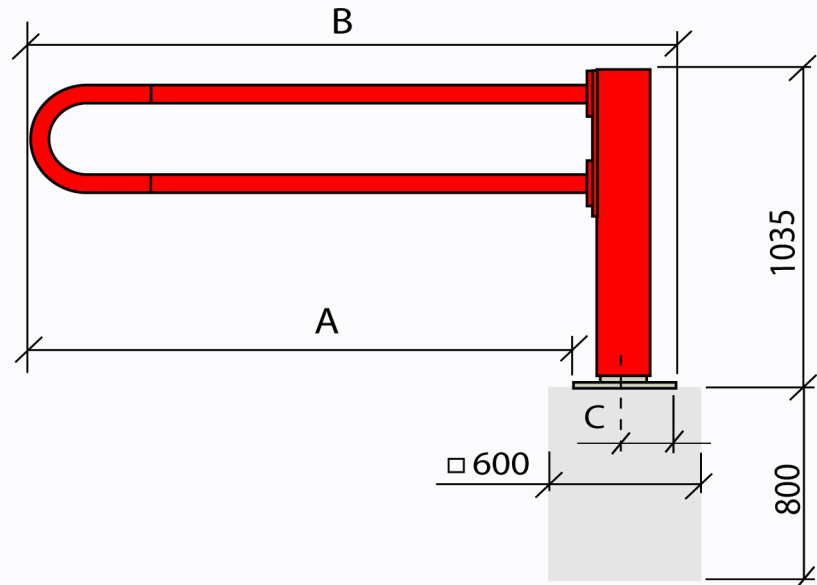
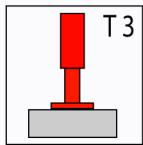

Durchfahrbreite A = 2454 mm
Gesamtbreite B = 2704 mm
Überstand C = 125 mm

Fundamentabstand
gegenläufiger Fundamentabstand

D = 0 mm
F = 5240 mm